

# REACTIVE POWER



## TECHNICAL SPECIFICATION

### INPUT

Rated value In	1 or 5 Amp C.T. connected 0.5-10 Amp direct connected
Rated value Un	57.8 < 600 volt
Power consumption	<1 VA voltage <0.2 VA current
Working range	0-125% Un auxiliary powered 75-125% Un self powered 0-150% In
Rated Frequency	50 / 60 / 400 Hz
Overload continuous	4 x In 1.5 x Un
Overload for 1 sec.	50 x In 2 x Un

### OUTPUT

Rated value mA 0-1/5/10/20 & 4-20mA

Rated Value Volts 0-5 / 10 & 1-5 V

### ADJUSTMENT

Zero	± 2%
Span	± 10%

### AUXILIARY

A.C. Voltage	115 / 230 / 400 V (± 25% / 45-65 Hz / < 2VA)
D.C. Voltage	24 / 48 / 110 V (± 20% / galvanically isolated / < 3W)

### WEIGHT & CASE SIZE

M100-XA1,2,3,6,7	Approx. 0.6kg. 100mm case
M100-XA4,5	Approx. 0.8kg 100mm case

## SELECTION GUIDE

M100-XA1	Single phase
M100-XA2	3 phase 3 wire balanced load
M100-XA3	3 phase 4 wire balanced load
M100-XA4	3 phase 3 wire unbalanced load
M100-XA5	3 phase 4 wire unbalanced load
M100-XA6	3 phase 3 wire unbalanced load
M100-XA7	3 phase 3 wire balanced load internally reversed C.T.s

## TYPICAL APPLICATIONS

The M100-XA series measure reactive power in single, 3 phase 3 or 4 wire balanced and unbalanced systems. Using the time division multiplier circuit means that they can be used over a wide range of input waveforms. The D.C. Output signal is directly proportional to the instantaneous reactive power being measured.

Typical applications include the measurement of reactive power in switchboards, power stations and generating sets etc. The high isolation of 4kV as with all the M100 series, allows these VAr transducers to be connected to a variety of measuring and control devices and systems, such as analogue meters, PLC, computers, data loggers, digital instruments and telemetry systems.

Both auxiliary powered and self powered versions of each type are available, it is recommended to use an auxiliary powered version if the system being measured has voltage variations in excess of ± 20%.

## ORDERING INFORMATION

Product code	I/P	In	Un	O/P	Range	Aux.	Freq.	Opt.
M100-XA4	400/5	400	0-20mA	300kVAr	120	60Hz		

## OPTIONS

1. Non standard inputs / outputs only as far as technically acceptable.
2. A.C. Auxiliary in range 57.7 to 450 volts
3. Calibration at nominal Hz 35.....450Hz
4. Calibration at temperature other than 23°C



Panel Components & Systems



# *REACTIVE POWER CONNECTION DIAGRAMS*

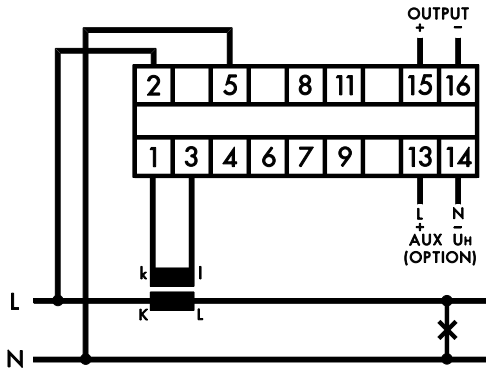

M100-XA1

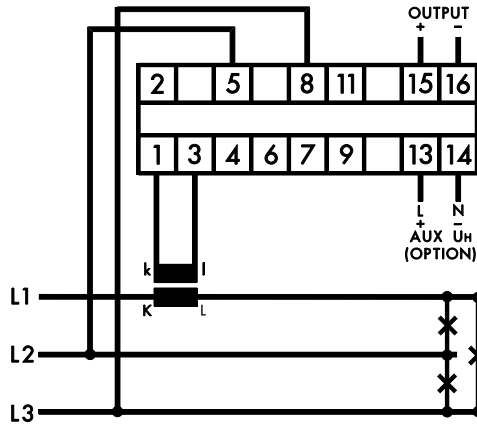

M100-XA2

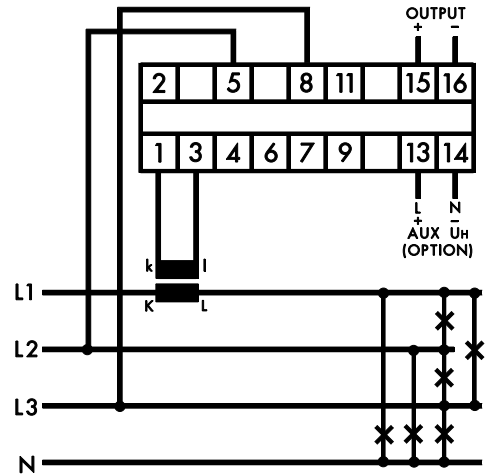

M100-XA3

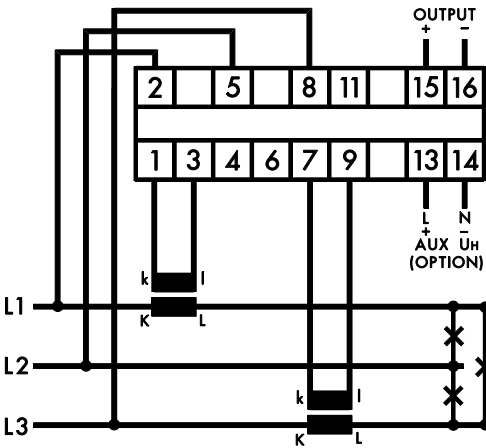

M100-XA4

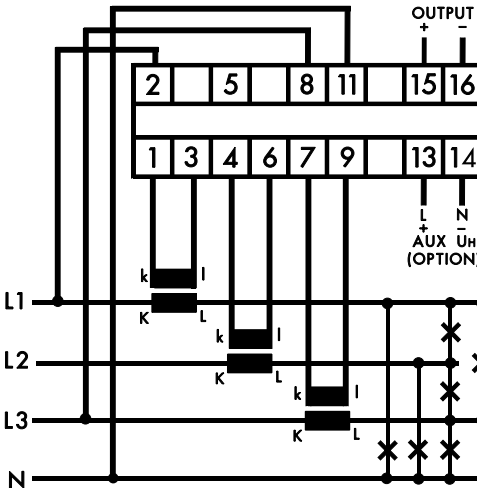

M100-XA5

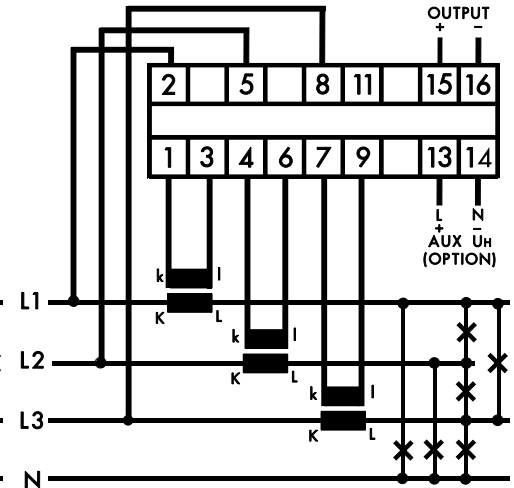

M100-XA6

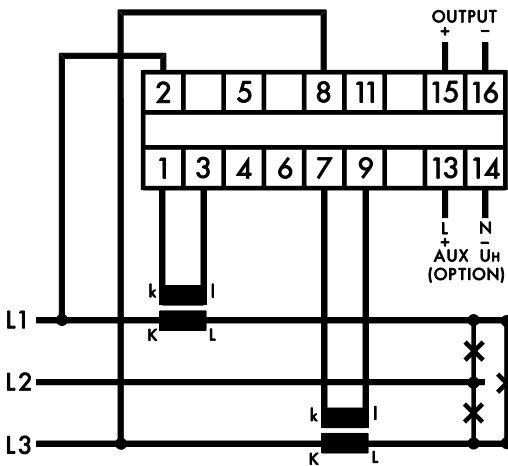

M100-XA7



**Power Measurement  
Specialists  
800-523-9194**

## GENERAL SPECIFICATIONS

### ENVIRONMENTAL

Working temperature	0 to +60 deg C
Functional temperature	-25 to +70 deg C
Storage temperature	-55 to +85 deg C
Temperature coefficient	0.02% per deg C (100 ppm / °C)
Relative humidity	95% non condensing
Class of climate	HSE complying with DIN 40040 -3 complying with VDE/VDI 3540

### INSULATION

Test voltage	4kV RMS 50Hz 1min. between Input / Case / Auxiliary / Output
Impulse test	EMC 5kV transient complying with IEC 801 / EN55020
HF interference test	EHF 2.5kV 1MHz complying with IEC 255-4
Protection class	II complying with IEC 348 BS 4753 / DIN 57411 / VDE 0411

### APPLIED STANDARDS

General	IEC 688 / BS 6253 / VDE/ VDI 2192
Safety	BS EN61010 DIN 57411 / VDE 0411 ANSI C37
Surge withstand	IEC 801 / EN 55020 ANSI C37-90a
Radio screening	RFI degree N complies with VDE 0875
EMC	Emissions EN50081-2 Immunity EN50082-1

### ACCURACY

Class	±0.2 % complying with IEC 688
Calibration temperature	23°C
Temperature coefficient	0.01% / °C (100 ppm / °C)
Stability	0.05 % per annum non cumulative
Warm up time	<15 min

### OUTPUT

Rated value	See individual product pages	
Load resistance mA	1mA	<15 kOhm
(Unless otherwise stated)	5mA	<3 kOhm
	10mA	<1.5 kOhm
	20mA	< 0.75kOhm
	4-20mA	< 0.75kOhm
Load resistance volts	1, 5 & 10 volts	>1 kOhm
(M100-VA1,VA3 only)	1, 5 & 10 volts	> 50kOhm
Load influence	<0.1 %	
Ripple	<0.5% peak-peak at full load	
Response time	<200 msec for 0-99 % at full load	
Overload	<2 x rated value at full load	
No load voltage	<27 V	

### ENCLOSURE

Fixing	Snap on to DIN rail 35 x 7.5 mm complies with DIN-EN 50022 BS 5584
Mounting	Any position
Enclosure Code	Case IP 50 / terminals IP 30 Complies with IEC 529 BS 5490 DIN 40050

### APPROVALS

cU.L. Approval	File No E157034
----------------	-----------------

### CASE DIMENSIONS

All Dimensions in mm

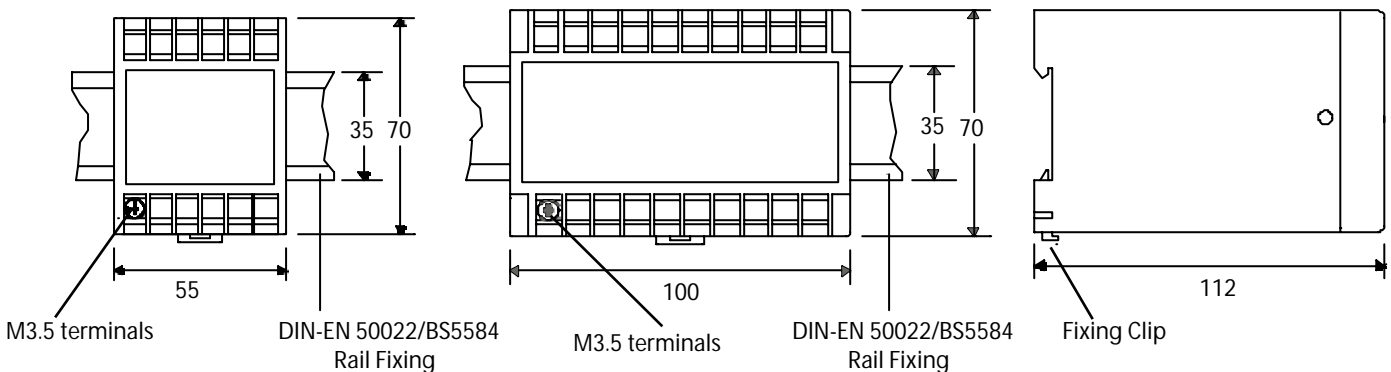

Panel Components & Systems

